

**DAIKIN**

**INVERTER**

DAIKIN ROOM AIR CONDITIONER

MODELS FTXL25J2V1B  
FTXL35J2V1B  
ATXL25J2V1B  
ATXL35J2V1B

***Operation Manual***

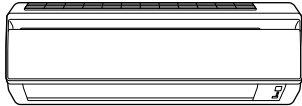

# CONTENTS

## **READ BEFORE OPERATION**

---

Safety precautions .....	2
Names of parts .....	4
Preparation Before Operation .....	7

## **OPERATION**

---

AUTO · DRY · COOL · HEAT · FAN Operation .....	10
Adjusting the Air Flow Direction .....	12
POWERFUL Operation .....	14
ECONO Operation .....	15
TIMER Operation .....	16

## **CARE**

---

Care and Cleaning .....	18
-------------------------	----

## **TROUBLESHOOTING**

---

Troubleshooting.....	22
----------------------	----

# Safety precautions

- Keep this manual where the operator can easily find them.
- Read this manual attentively before starting up the unit.
- For safety reason the operator must read the following cautions carefully.
- This manual classifies precautions into WARNINGS and CAUTIONS. Be sure to follow all precautions below: they are all important for ensuring safety.

## **WARNING**

If you do not follow these instructions exactly, the unit may cause property damage, personal injury or loss of life.

## **CAUTION**

If you do not follow these instructions exactly, the unit may cause minor or moderate property damage or personal injury.



Never do.



Be sure to earth the air conditioner.



Never touch the air conditioner (including the remote controller) with a wet hand.





Be sure to follow the instructions.



Never cause the air conditioner (including the remote controller) to get wet.

## **WARNING**

- In order to avoid fire, explosion or injury, do not operate the unit when harmful gases (e.g. flammable or corrosive) are detected near the unit. 
  - It is not good for health to expose your body to the air flow for a long time.
  - Do not put a finger, a rod or other objects into the air outlet or inlet. As the fan is rotating at a high speed, it will cause injury.
  - Do not attempt to repair, relocate, modify or reinstall the air conditioner by yourself. Incorrect work will cause electric shocks, fire etc.
- For repairs and reinstallation, consult your Daikin dealer for advice and information.

- The refrigerant used in the air conditioner is safe. Although leaks should not occur, if for some reason any refrigerant happens to leak into the room, make sure it does not come in contact with any flame as of gas heaters, kerosene heaters or gas range. 
- If the air conditioner is not cooling (heating) properly, the refrigerant may be leaking, so call your dealer. When carrying out repairs accompanying adding refrigerant, check the content of the repairs with our service staff.
- Do not attempt to install the air conditioner by yourself. Incorrect work will result in water leakage, electric shocks or fire. For installation, consult the dealer or a qualified technician.
- In order to avoid electric shock, fire or injury, if you detect any abnormality such as smell of fire, stop the operation and turn off the breaker. And call your dealer for instructions.
- Depending on the environment, an earth leakage breaker must be installed. Lack of an earth leakage breaker may result in electric shocks or fire.

- The air conditioner must be earthed. Incomplete earthing may result in electric shocks. Do not connect the earth line to a gas pipe, water pipe, lightning rod, or a telephone earth line. 

## **CAUTION**

- In order to avoid any quality deterioration, do not use the unit for cooling precision instruments, food, plants, animals or works of art. 
- Never expose little children, plants or animals directly to the air flow.
- Do not place appliances which produce open fire in places exposed to the air flow from the unit or under the indoor unit. It may cause incomplete combustion or deformation of the unit due to the heat.

- Do not block air inlets nor outlets. Impaired air flow may result in insufficient performance or trouble.
- Do not stand or sit on the outdoor unit. Do not place any object on the unit to avoid injury, do not remove the fan guard.
- Do not place anything under the indoor or outdoor unit that must be kept away from moisture. In certain conditions, moisture in the air may condense and drip.
- After a long use, check the unit stand and fittings for damage.
- Do not touch the air inlet and aluminium fins of outdoor unit. It may cause injury.
- The appliance is not intended for use by young children or infirm persons without supervision.
- Young children should be supervised to ensure that they do not play with the appliance.

- To avoid oxygen deficiency, ventilate the room sufficiently if equipment with burner is used together with the air conditioner. 
- Before cleaning, be sure to stop the operation, turn the breaker off or pull out the supply cord.
- Do not connect the air conditioner to a power supply different from the one as specified. It may cause trouble or fire.
- Arrange the drain hose to ensure smooth drainage. Incomplete draining may cause wetting of the building, furniture etc.
- Do not place objects in direct proximity of the outdoor unit and do not let leaves and other debris accumulate around the unit.  
Leaves are a hotbed for small animals which can enter the unit. Once in the unit, such animals can cause malfunctions, smoke or fire when making contact with electrical parts.

- Do not operate the air conditioner with wet hands. 

- Do not wash the indoor unit with excessive water, only use a slightly wet cloth.
- Do not place things such as vessels containing water or anything else on top of the unit. Water may penetrate into the unit and degrade electrical insulations, resulting in an electric shock. 

### **Installation site.**

- To install the air conditioner in the following types of environments, consult the dealer.
  - Places with an oily environment or where steam or soot occurs.
  - Salty environment such as coastal areas.
  - Places where sulfide gas occurs such as hot springs.
  - Places where snow may block the outdoor unit.

The drain from the outdoor unit must be discharged to a place of good drainage.

### **Consider nuisance to your neighbours from noises.**

- For installation, choose a place as described below.
  - A place solid enough to bear the weight of the unit which does not amplify the operation noise or vibration.
  - A place from where the air discharged from the outdoor unit or the operation noise will not annoy your neighbours.

### **Electrical work.**

- For power supply, be sure to use a separate power circuit dedicated to the air conditioner.

### **System relocation.**

- Relocating the air conditioner requires specialized knowledge and skills. Please consult the dealer if relocation is necessary for moving or remodeling.

# Names of parts

## ■ Indoor Unit

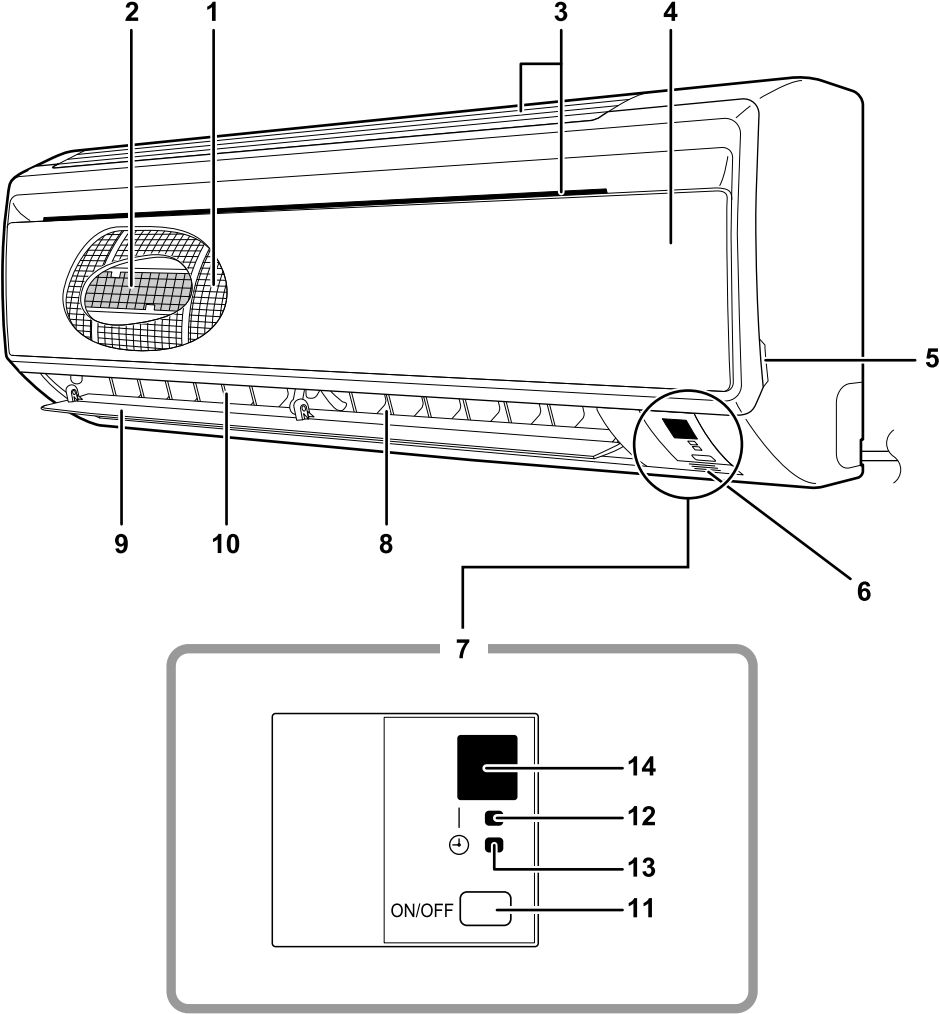

## ■ Outdoor Unit

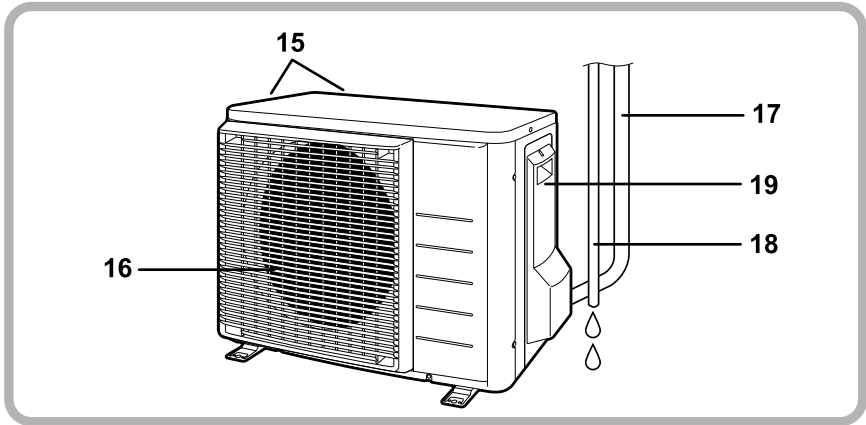

### ■ Indoor Unit

1. Air filter
2. Titanium Apatite Photocatalytic Air-Purifying Filter:
  - These filters are attached to the inside of the air filters.
3. Air inlet
4. Front panel
5. Panel tab
6. Room temperature sensor:
  - It senses the air temperature around the unit.
7. Display
8. Air outlet
9. Horizontal blades (Flaps): (page 12.)
10. Vertical blades (Louvers):
  - The louvers are inside of the air outlet. (page 12.)

#### 11. Indoor unit ON/OFF switch: (page 10.)

- Push this switch once to start operation. Push once again to stop it.
- The operation mode refers to the following table.

Mode	Temperature setting	Air flow rate
AUTO	25°C	AUTO

- This switch is useful when the remote controller is missing.

#### 12. Operation lamp (green)

#### 13. TIMER lamp (yellow): (page 16.)

#### 14. Signal receiver:

- It receives signals from the remote controller.
- When the unit receives a signal, you will hear a short beep.
  - Operation start .....beep-beep
  - Settings changed .....beep
  - Operation stop .....beeeeeep

### ■ Outdoor Unit

15. Air inlet: (Back and side)
16. Air outlet
17. Refrigerant piping and inter-unit cable

#### 18. Drain hose

#### 19. Earth terminal:

- It is inside of this cover.

Appearance of the outdoor unit may differ from some models.

# ■ Remote Controller

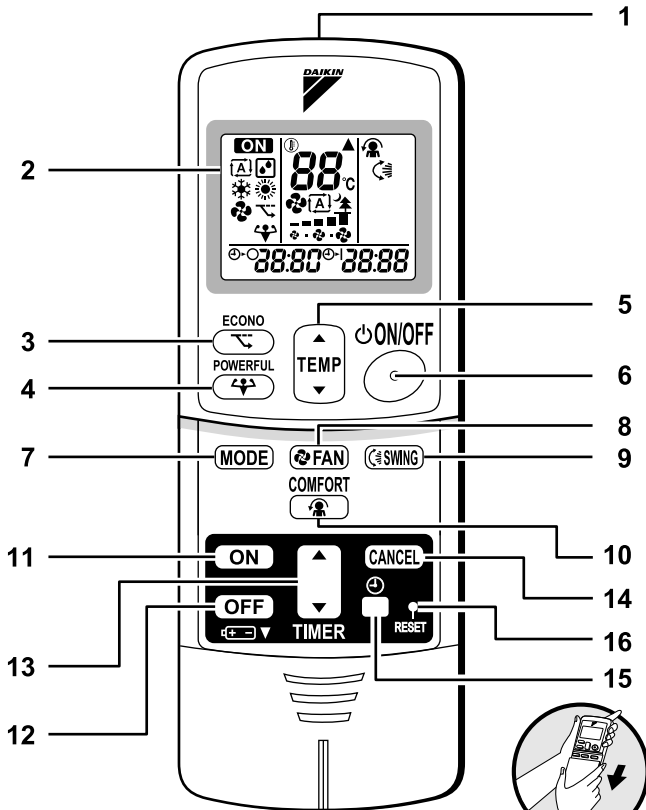

<ARC433A87, A88>

## 1. Signal transmitter:

- It sends signals to the indoor unit.

## 2. Display:

- It displays the current settings.  
(In this illustration, each section is shown with all its displays ON for the purpose of explanation.)

## 3. ECONO button:

- ECONO operation (page 15.)

## 4. POWERFUL button:

- POWERFUL operation (page 14.)

## 5. TEMPERATURE adjustment buttons:

- It changes the temperature setting.

## 6. ON/OFF button:

- Press this button once to start operation.  
Press once again to stop it.

## 7. MODE selector button:

- It selects the operation mode.  
(AUTO/DRY/COOL/HEAT/FAN) (page 10.)

## 8. FAN setting button:

- It selects the air flow rate setting.

## 9. SWING button:

- Adjusting the Airflow Direction. (page 12.)

## 10. COMFORT AIRFLOW button: COMFORT AIRFLOW operation (page 13.)

## 11. ON TIMER button: (page 17.)

## 12. OFF TIMER button: (page 16.)

## 13. TIMER Setting button:

- It changes the time setting.

## 14. TIMER CANCEL button:

- It cancels the timer setting.

## 15. CLOCK button: (page 9.)

## 16. RESET button:

- Restart the unit if it freezes.  
• Use a thin object to push.

# Preparation Before Operation

## ■ To set the batteries

1. Slide the front cover to take it off.
2. Set two dry batteries AAA.LR03 (alkaline).
3. Set the front cover as before.

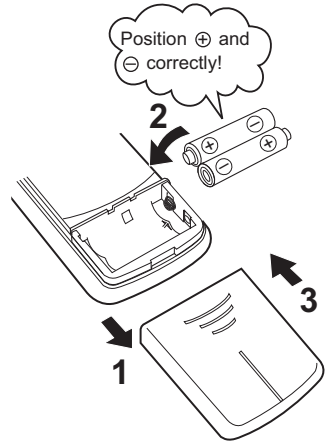

## ATTENTION

### ■ About batteries

- When replacing the batteries, use batteries of the same type, and replace the two old batteries together.
- When the system is not used for a long time, take the batteries out.
- The batteries will last for approximately one year. If the remote controller display begins to fade and the degradation of reception performance occurs within a year, however, replace both two batteries with new, size AAA.LR03(alkaline).
- The attached batteries are provided for the initial use of the system.  
The usable period of the batteries may be short depending on the manufactured date of the air conditioner.



# Preparation Before Operation

## ■ To operate the remote controller

- To use the remote controller, aim the transmitter at the indoor unit. If there is anything to block signals between the unit and the remote controller, such as a curtain, the unit will not operate.
- Do not drop the remote controller. Do not get it wet.
- The maximum distance for communication is about 7m.

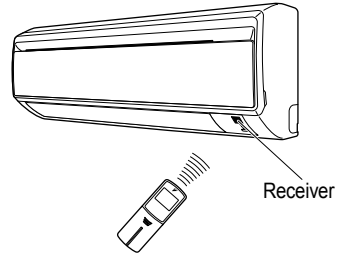

## ■ To fix the remote controller holder on the wall

1. Choose a place from where the signals reach the unit.
2. Fix the holder to a wall, a pillar, or similar location with the screws procured locally.
3. Place the remote controller in the remote controller holder.

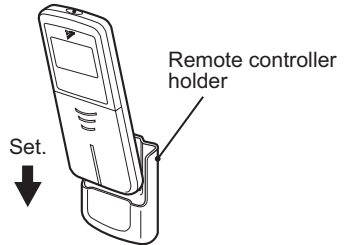

- To remove, pull it upwards.

## ATTENTION

### ■ About remote controller

- Never expose the remote controller to direct sunlight.
- Dust on the signal transmitter or receiver will reduce the sensitivity. Wipe off dust with soft cloth.
- Signal communication may be disabled if an electronic-starter-type fluorescent lamp (such as inverter-type lamps) is in the room. Consult the shop if that is the case.
- If the remote controller signals happen to operate another appliance, move that appliance to somewhere else, or consult the shop.

## ■ To set the clock

### 1. Press “CLOCK button”.

0:00 is displayed.

⌚ blinks.

### 2. Press “TIMER setting button” to set the clock to the present time.

Holding down “▲” or “▼” button rapidly increases or decreases the time display.

### 3. Press “CLOCK button”.

⌚ blinks.

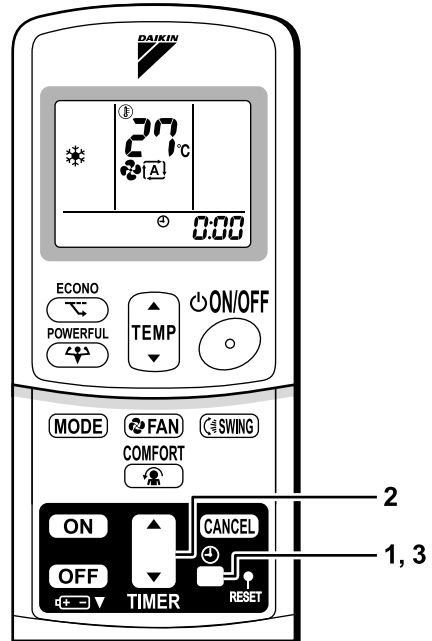

## ■ Turn the breaker ON

- Turning ON the breaker opens the flap, then closes it again. (This is a normal procedure.)

## NOTE

### ■ Tips for saving energy

- Be careful not to cool (heat) the room too much. Keeping the temperature setting at a moderate level helps save energy.
- Cover windows with a blind or a curtain. Blocking sunlight and air from outdoors increases the cooling (heating) effect.
- Clogged air filters cause inefficient operation and waste energy. Clean them once in about every two weeks.

#### Recommended temperature setting

For cooling: 26°C – 28°C  
For heating: 20°C – 24°C

### ■ Please note

- The air conditioner always consumes 15-35 watts of electricity even while it is not operating.
- If you are not going to use the air conditioner for a long period, for example in spring or autumn, turn the breaker OFF.
- Use the air conditioner in the following conditions.

Mode	Operating conditions	If operation is continued out of this range
COOL	Outdoor temperature: -10 – 46°C Indoor temperature: 18 – 32°C Indoor humidity: 80% max.	<ul style="list-style-type: none"> <li>• A safety device may work to stop the operation.</li> <li>• Condensation may occur on the indoor unit and drip.</li> </ul>
HEAT	Outdoor temperature: <RXLS, RXL, ARXL> -25 – 24°C Indoor temperature: 10 – 30°C	<ul style="list-style-type: none"> <li>• A safety device may work to stop the operation.</li> </ul>
DRY	Outdoor temperature: -10 – 46°C Indoor temperature: 18 – 32°C Indoor humidity: 80% max.	<ul style="list-style-type: none"> <li>• A safety device may work to stop the operation.</li> <li>• Condensation may occur on the indoor unit and drip.</li> </ul>

- Operation outside this humidity or temperature range may cause a safety device to disable the system.

# AUTO · DRY · COOL · HEAT · FAN Operation

The air conditioner operates with the operation mode of your choice.

From the next time on, the air conditioner will operate with the same operation mode.

## ■ To start operation

### 1. Press “MODE selector button” and select an operation mode.

- Each pressing of the button advances the mode setting in sequence.

: AUTO

: DRY

: COOL

: HEAT

: FAN

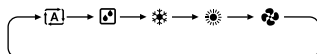

### 2. Press “ON/OFF button” .

- The OPERATION lamp lights up.



## ■ To stop operation

### 3. Press “ON/OFF button” again.

- Then OPERATION lamp goes off.

## ■ To change the temperature setting



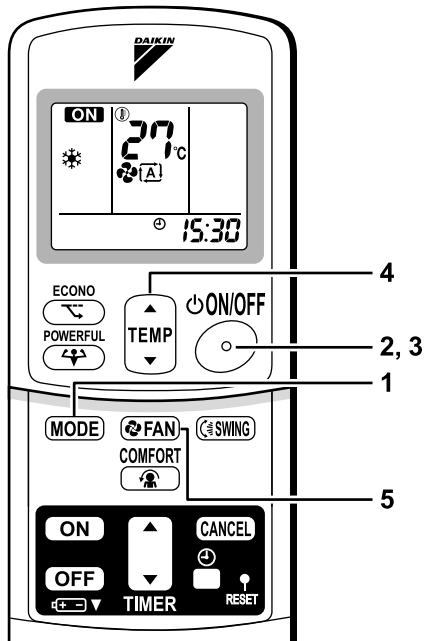

### 4. Press “TEMPERATURE adjustment button”.

DRY or FAN mode	AUTO or COOL or HEAT mode
The temperature setting is not variable.	Press “▲” to raise the temperature and press “▼” to lower the temperature.
	Set to the temperature you like. 



## ■ To change the air flow rate setting

### 5. Press “FAN setting button”.

DRY mode	AUTO or COOL or HEAT or FAN mode
The air flow rate setting is not variable.	Five levels of air flow rate setting from “  ” to “  ” plus “  ” “  ” are available. 

- Indoor unit quiet operation  
When the air flow is set to “”, the noise from the indoor unit will become quieter. Use this when making the noise quieter.  
The unit might lose capacity when the air flow rate is set to a weak level.

## NOTE

### ■ Note on HEAT operation

- Since this air conditioner heats the room by taking heat from outdoor air to indoors, the heating capacity becomes smaller in lower outdoor temperatures. If the heating effect is insufficient, it is recommended to use another heating appliance in combination with the air conditioner.
- The heat pump system heats the room by circulating hot air around all parts of the room. After the start of heating operation, it takes some time before the room gets warmer.
- In heating operation, frost may occur on the outdoor unit and lower the heating capacity. In that case, the system switches into defrosting operation to take away the frost.
- During defrosting operation, hot air does not flow out of indoor unit.
- When the indoor temperature reaches the demanded temperature the unit stops heating. However, the indoor fan is in operation. This is standard condition.

### ■ Note on COOL operation

- This air conditioner cools the room by blowing the hot air in the room outside, so if the outside temperature is high, the performance of the air conditioner drops.

### ■ Note on DRY operation

- The computer chip works to rid the room of humidity while maintaining the temperature as much as possible. It automatically controls temperature and fan strength, so manual adjustment of these functions is unavailable.

### ■ Note on AUTO operation

- In AUTO operation, the system selects an appropriate operation mode (COOL or HEAT) based on the room temperature at the start of the operation.
- The system automatically reselects setting at a regular interval to bring the room temperature to user-setting level.
- If you do not like AUTO operation, manually change the set temperature.



### ■ Note on air flow rate setting

- At smaller air flow rates, the cooling (heating) effect is also smaller.

# Adjusting the Air Flow Direction

You can adjust the air flow direction to increase your comfort.

## ■ To adjust the horizontal blades (flaps)

1. Press “SWING button”.
  - “” is displayed on the LCD and the flaps will begin to swing.
2. When the flaps have reached the desired position, press “SWING button” once more.
  - The flaps will stop moving.
  - “” disappears from the LCD.

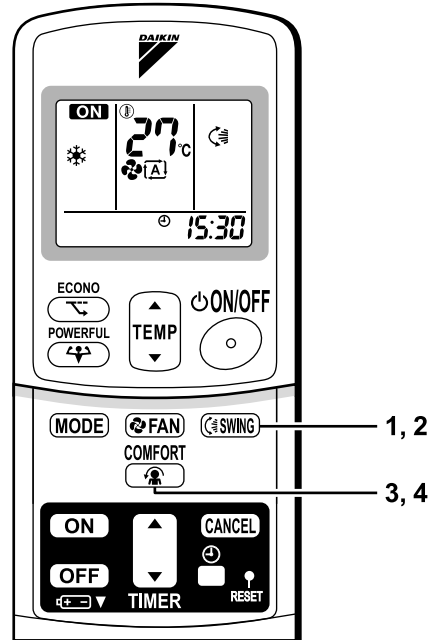

## ■ To adjust the vertical blades (louvers)

Hold the knob and move the louvers.  
(You will find a knob on the left-side and the right-side blades.)

- When the unit is installed in the corner of a room, the direction of the louvers should be facing away from the wall.  
If they face the wall, the wall will block off the wind, causing the cooling (or heating) efficiency to drop.

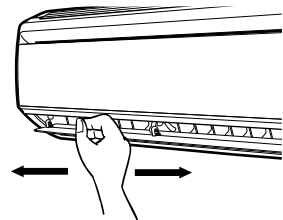

## ■ To start COMFORT AIRFLOW operation

### 3. Press “COMFORT AIRFLOW button”.

- The position of the flaps will change, preventing air from blowing directly on the occupants of the room.
- “” is displayed on the LCD.
- Airflow rate is set to “AUTO”.  
(COOL/DRY) The flaps will go up.  
(HEAT) The flaps will go down.

## ■ To cancel COMFORT AIRFLOW operation

### 4. Press “COMFORT AIRFLOW button” again.

- The flaps will return to the memory position from before COMFORT AIRFLOW mode.
- “” disappears from the LCD.

## Notes on COMFORT AIRFLOW operation

- POWERFUL operation and COMFORT AIRFLOW operation cannot be used at the same time. Priority is given to POWERFUL operation.

## Notes on flaps and louvers angles.

- When “**SWING button**” is selected, the flaps swinging range depends on the operation mode. (See the figure.)

### ■ ATTENTION

- Always use a remote controller to adjust the flaps angle. If you attempt to move it forcibly with hand when it is swinging, the mechanism may be broken.
- Be careful when adjusting the louvers. Inside the air outlet, a fan is rotating at a high speed.
- If the air conditioner is operated in cooling or dry mode with the flaps kept stopped in the downward direction, the flaps will automatically start operating in approximately an hour in order to prevent dew condensation.

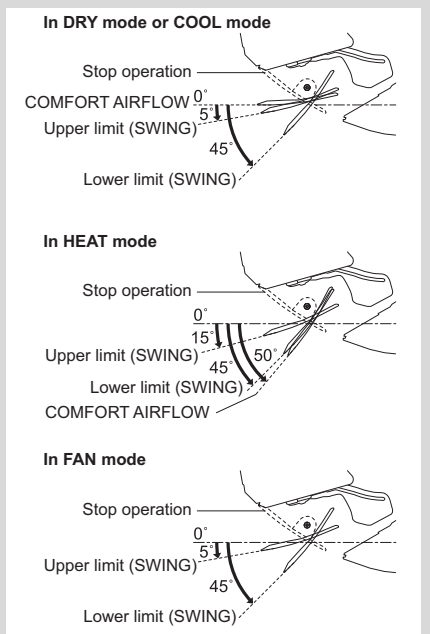

# POWERFUL Operation

POWERFUL operation quickly maximizes the cooling (heating) effect in any operation mode. You can get the maximum capacity .

## ■ To start POWERFUL operation

1. Press “POWERFUL button”.
  - POWERFUL operation ends in 20 minutes. Then the system automatically operates again with the settings which were used before POWERFUL operation.
  - “” is displayed on the LCD.
  - When using POWERFUL operation, there are some functions which are not available.

## ■ To cancel POWERFUL operation

2. Press “POWERFUL button” again.
  - “” disappears from the LCD.

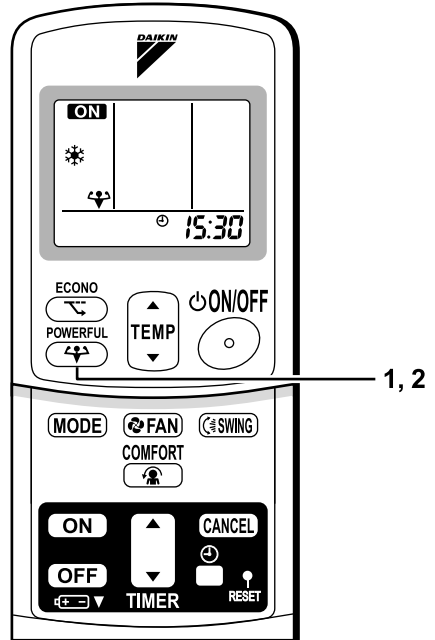

## NOTE

### ■ Notes on POWERFUL operation

- POWERFUL Operation cannot be used together with ECONO or COMFORT AIRFLOW Operation. Priority is given to the function of whichever button is pressed last.
- POWERFUL Operation can only be set when the unit is running. Pressing the operation stop button causes the settings to be canceled, and the “” disappears from the LCD.
- **In COOL and HEAT mode**  
To maximize the cooling (heating) effect, the capacity of outdoor unit must be increased and the air flow rate be fixed to the maximum setting.  
The temperature and air flow settings are not variable.
- **In DRY mode**  
The temperature setting is lowered by 2.5°C and the air flow rate is slightly increased.
- **In FAN mode**  
The air flow rate is fixed to the maximum setting.

# ECONO Operation

ECONO operation is a function which enables efficient operation by lowering the maximum power consumption value.

## ■ To start ECONO operation

1. Press “ECONO button”.
  - “” is displayed on the LCD.

## ■ To cancel ECONO operation

2. Press “ECONO button” again.
  - “” disappears from the LCD.

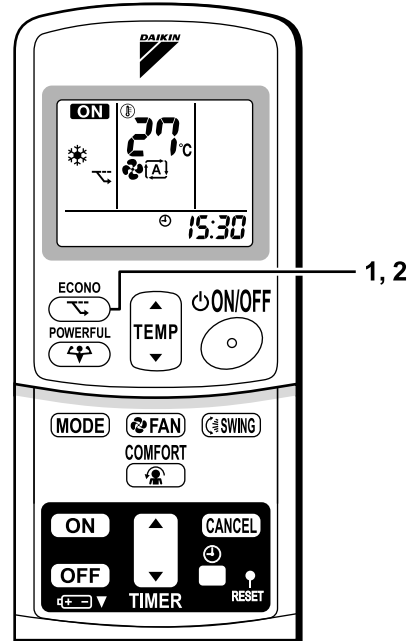

## NOTE

- ECONO Operation can only be set when the unit is running. Pressing the operation stop button causes the settings to be canceled, and the “” disappears from the LCD.
- ECONO operation is a function which enables efficient operation by limiting the power consumption of the outdoor unit (operating frequency).
- ECONO operation functions in AUTO, COOL, DRY, and HEAT modes.
- POWERFUL operation and ECONO operation cannot be used at the same time. Priority is given to the function of whichever button is pressed last.
- Power consumption may not drop even if ECONO operation is used, when the level of power consumption is already low.



# TIMER Operation

Timer functions are useful for automatically switching the air conditioner on or off at night or in the morning. You can also use OFF TIMER and ON TIMER in combination.

## ■ To use OFF TIMER operation

- Check that the clock is correct.  
If not, set the clock to the present time.  
(page 9.)

### 1. Press “OFF TIMER button”.

0:00 is displayed.

⊕-⊖ blinks.

### 2. Press “TIMER Setting button” until the time setting reaches the point you like.

- Every pressing of either button increases or decreases the time setting by 10 minutes. Holding down either button changes the setting rapidly.

### 3. Press “OFF TIMER button” again.

- The TIMER lamp lights up.

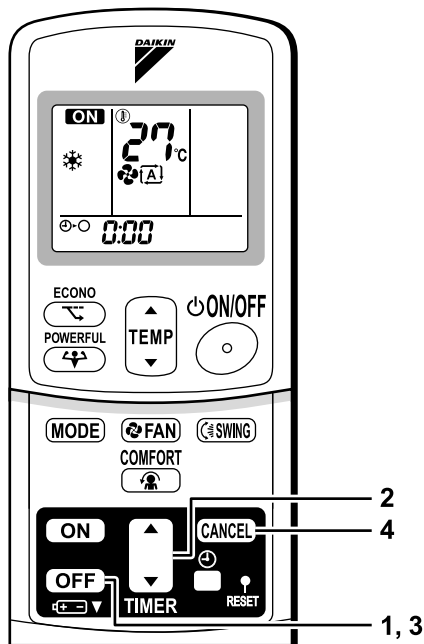
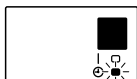

## ■ To cancel the OFF TIMER operation

### 4. Press “CANCEL button”.

- The TIMER lamp goes off.

## NOTE

- When TIMER is set, the present time is not displayed.
- Once you set ON, OFF TIMER, the time setting is kept in the memory. (The memory is canceled when remote controller batteries are replaced.)
- When operating the unit via the ON/OFF Timer, the actual length of operation may vary from the time entered by the user.

### ■ NIGHT SET MODE

When the OFF TIMER is set, the air conditioner automatically adjusts the temperature setting (0.5°C up in COOL, 2.0°C down in HEAT) to prevent excessive cooling (heating) for your pleasant sleep.

## ■ To use ON TIMER operation

- Check that the clock is correct. If not, set the clock to the present time (page 9.).

### 1. Press “ON TIMER button”.

6:00 is displayed.

⊙-| blinks.

### 2. Press “TIMER Setting button” until the time setting reaches the point you like.

- Every pressing of either button increases or decreases the time setting by 10 minutes. Holding down either button changes the setting rapidly.

### 3. Press “ON TIMER button” again.

- The TIMER lamp lights up.

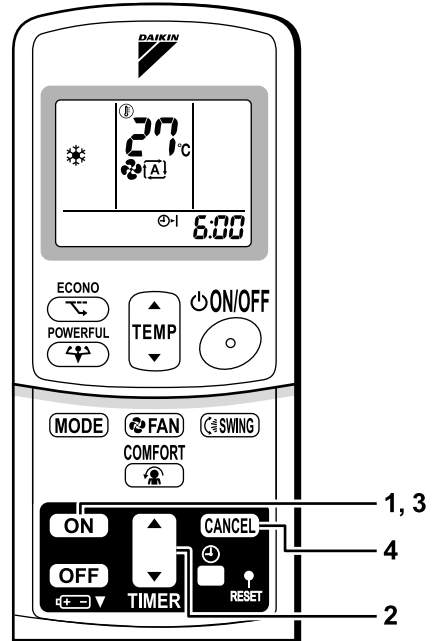

## ■ To cancel ON TIMER operation

### 4. Press “CANCEL button”.

- The TIMER lamp goes off.

## ■ To combine ON TIMER and OFF TIMER

- A sample setting for combining the two timers is shown below.

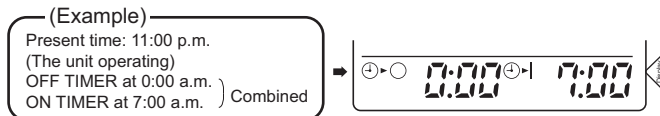

## ATTENTION

### ■ In the following cases, set the timer again.

- After a breaker has turned OFF.
- After a power failure.
- After replacing batteries in the remote controller.

# Care and Cleaning



**CAUTION** Before cleaning, be sure to stop the operation and turn the breaker OFF.

## Units

### ■ Indoor unit, Outdoor unit and Remote controller

1. Wipe them with dry soft cloth.

### ■ Front panel

#### 1. Open the front panel.

- Hold the panel at the recesses on the main unit (2 recesses on right and left sides) and lift it until it stops.

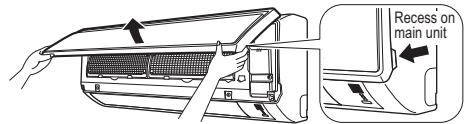

#### 2. Remove the front panel.

- While lifting the front panel further, slide it to the right and pull it to the front side. The left rotating shaft is detached. Slide the right rotating shaft to the left and pull it to the front side to remove it.

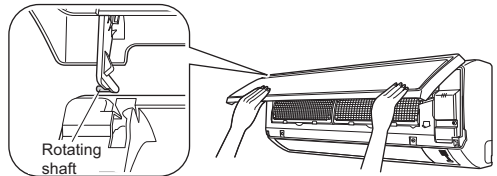

#### 3. Attach the front panel.

- Align the right and left rotating shafts of the front panel with the grooves and push them all the way in.
- Gently close the front panel. (Push both ends and the center on the front panel.)

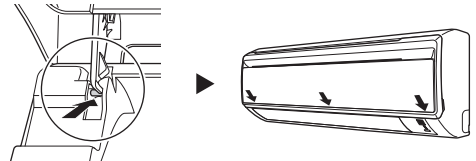

### CAUTION

- Don't touch the metal parts of the indoor unit. If you touch those parts, this may cause an injury.
- When removing or attaching the front panel, use a robust and stable stool and watch your steps carefully.
- When removing or attaching the front panel, support the panel securely with hand to prevent it from falling.
- For cleaning, do not use hot water above 40°C, benzine, gasoline, thinner, nor other volatile oils, polishing compound, scrubbing brushes, nor other hand stuff.
- After cleaning, make sure that the front panel is securely fixed.

## Filters

### 1. Open the front panel. (page 18.)

- Hold the panel at the recesses on the main unit (2 recesses on right and left sides) and lift it until it stops.

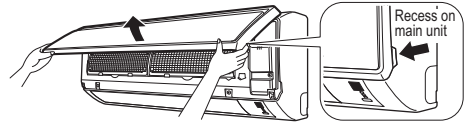

### 2. Pull out the air filters.

- Push the filter tab at the center of each air filter a little upwards, then pull it down.

### 3. Take off the Titanium Apatite Photocatalytic Air-Purifying Filter.

- Hold the recessed parts of the frame and unhook the four claws.

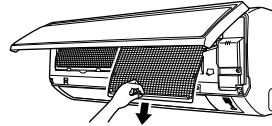

### 4. Clean or replace each filter.

See figure.

- When shaking off remaining water, do not wring the filter.

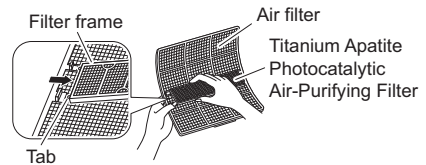

### 5. Set the air filter and Titanium Apatite Photocatalytic Air-Purifying Filter as they were and close the front panel.

- Insert claws of the filters into slots of the front panel. Close the front panel slowly and push the panel at the 3 points. (1 on each side and 1 in the middle.)
- The air filter and the Titanium Apatite Photocatalytic Air-Purifying Filter have a symmetrical form in the horizontal direction.

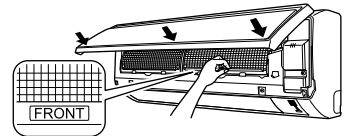

## ■ Air Filter

### 1. Wash the air filters with water or clean them with vacuum cleaner.

- If the dust does not come off easily, wash them with neutral detergent thinned with lukewarm water, then dry them up in the shade.
- It is recommended to clean the air filters every two weeks.

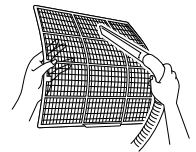

## ■ Titanium Apatite Photocatalytic Air-Purifying Filter.

The Titanium Apatite Photocatalytic Air-Purifying Filter can be renewed by washing it with water once every 6 months. We recommend replacing it once every 3 years.

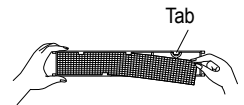

## [ Maintenance ]

1. Remove dust with a vacuum cleaner and wash lightly with water.
2. If it is very dirty, soak it for 10 to 15 minutes in water mixed with a neutral cleaning agent.
3. Do not remove filter from frame when washing with water.
4. After washing, shake off remaining water and dry in the shade.
5. When shaking off remaining water, do not wring the filter.

## [ Replacement ]

1. Remove the tabs on the filter frame and replace with a new filter.
  - Dispose of old filters as non-flammable waste.

## NOTE

- Operation with dirty filters :
  - (1) cannot deodorize the air.
  - (2) cannot clean the air.
  - (3) results in poor heating or cooling.
  - (4) may cause odour.
- To order air purifying filter or Photocatalytic deodorizing filter, contact the service shop where you bought the air conditioner.
- Dispose of old air filters as non-burnable waste.

Item	Part No.
Titanium Apatite Photocatalytic Air-Purifying Filter. (without frame) 1 set	KAF970A46

## ■ Winter season

If you decide to remove unwanted icicles, use gloves to avoid injury and unit damage.

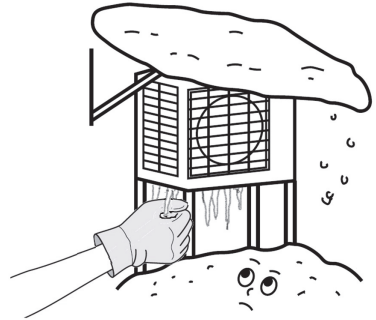

## Check

Check that the base, stand and other fittings of the outdoor unit are not decayed or corroded.
Check that nothing blocks the air inlets and the outlets of the indoor unit and the outdoor unit.
Check that the drain comes smoothly out of the drain hose during COOL or DRY operation. <ul style="list-style-type: none"><li>• If no drain water is seen, water may be leaking from the indoor unit. Stop operation and consult the service shop if this is the case.</li></ul>

## ■ Before a long idle period

- 1. Operate the “FAN only” for several hours on a fine day to dry out the inside.**
  - Press “MODE selector button” and select “FAN”operation.
  - Press “ON/OFF button” and start operation.
- 2. After operation stops, turn off the breaker for the room air conditioner.**
- 3. Clean the air filters and set them again.**
- 4. Take out batteries from the remote controller.**

# Troubleshooting

## These cases are not troubles.

The following cases are not air conditioner troubles but have some reasons. You may just continue using it.

Case	Explanation
<b>Operation does not start soon.</b> <ul style="list-style-type: none"> <li>When ON/OFF button was pressed soon after operation was stopped.</li> <li>When the mode was reselected.</li> </ul>	<ul style="list-style-type: none"> <li>This is to protect the air conditioner. You should wait for about 3 minutes.</li> </ul>
<b>Hot air does not flow out soon after the start of heating operation.</b>	<ul style="list-style-type: none"> <li>The air conditioner is warming up. You should wait for 1 to 4 minutes. (The system is designed to start discharging air only after it has reached a certain temperature.)</li> </ul>
<b>The heating operation stops suddenly and a flowing sound is heard.</b>	<ul style="list-style-type: none"> <li>The system is taking away the frost on the outdoor unit. You should wait for about 3 to 8 minutes.</li> </ul>
<b>The outdoor unit emits water or steam.</b>	<ul style="list-style-type: none"> <li>In HEAT mode           <ul style="list-style-type: none"> <li>The frost on the outdoor unit melts into water or steam when the air conditioner is in defrost operation.</li> </ul> </li> <li>In COOL or DRY mode           <ul style="list-style-type: none"> <li>Moisture in the air condenses into water on the cool surface of outdoor unit piping and drips.</li> </ul> </li> </ul>
<b>Mist comes out of the indoor unit.</b>	<ul style="list-style-type: none"> <li>This happens when the air in the room is cooled into mist by the cold air flow during cooling operation.</li> </ul>
<b>The indoor unit gives out odour.</b>	<ul style="list-style-type: none"> <li>This happens when smells of the room, furniture, or cigarettes are absorbed into the unit and discharged with the air flow. (If this happens, we recommend you to have the indoor unit washed by a technician. Consult the service shop where you bought the air conditioner.)</li> </ul>
<b>The outdoor fan rotates while the air conditioner is not in operation.</b>	<ul style="list-style-type: none"> <li>After operation is stopped:           <ul style="list-style-type: none"> <li>The outdoor fan continues rotating for another 60 seconds for system protection.</li> </ul> </li> <li>While the air conditioner is not in operation:           <ul style="list-style-type: none"> <li>When the outdoor temperature is very high, the outdoor fan starts rotating for system protection.</li> </ul> </li> </ul>
<b>The operation stopped suddenly. (OPERATION lamp is on.)</b>	<ul style="list-style-type: none"> <li>For system protection, the air conditioner may stop operating on a sudden large voltage fluctuation. It automatically resumes operation in about 3 minutes.</li> </ul>
<b>No remote controller signals are displayed.</b> <b>The remote controller sensitivity is low.</b> <b>The display is low in contrast or blacked out.</b> <b>The display runs out of control.</b>	<ul style="list-style-type: none"> <li>The batteries are dying and the remote controller is malfunctioning. Replace all the batteries with new, size AAA, alkaline batteries. For details, refer to "To set the batteries" of this manual. (page 7.)</li> <li>* If the reset button is provided, press the reset button after the batteries are replaced.</li> </ul>

**Check again.**

Please check again before calling a repair person.

<b>Case</b>	<b>Check</b>
<b>The air conditioner does not operate. (OPERATION lamp is off.)</b>	<ul style="list-style-type: none"><li>• Hasn't a breaker turned OFF or a fuse blown?</li><li>• Isn't it a power failure?</li><li>• Are batteries set in the remote controller?</li><li>• Is the timer setting correct?</li></ul>
<b>Cooling (Heating) effect is poor.</b>	<ul style="list-style-type: none"><li>• Are the air filters clean?</li><li>• Is there anything to block the air inlet or the outlet of the indoor and the outdoor units?</li><li>• Is the temperature setting appropriate?</li><li>• Are the windows and doors closed?</li><li>• Are the air flow rate and the air direction set appropriately?</li></ul>
<b>Operation stops suddenly. (OPERATION lamp flashes.)</b>	<ul style="list-style-type: none"><li>• Are the air filters clean?</li><li>• Is there anything to block the air inlet or the outlet of the indoor and the outdoor units?</li></ul> <p>Clean the air filters or take all obstacles away and turn the breaker OFF. Then turn it ON again and try operating the air conditioner with the remote controller. If the lamp still flashes, call the service shop where you bought the air conditioner.</p>
<b>An abnormal functioning happens during operation.</b>	<ul style="list-style-type: none"><li>• The air conditioner may malfunction with lightning or radio waves. Turn the breaker OFF, turn it ON again and try operating the air conditioner with the remote controller.</li></ul>



## Call the service shop immediately.

### WARNING

- When an abnormality (such as a burning smell) occurs, stop operation and turn the breaker OFF. Continued operation in an abnormal condition may result in troubles, electric shocks or fire. Consult the service shop where you bought the air conditioner.
- Do not attempt to repair or modify the air conditioner by yourself. Incorrect work may result in electric shocks or fire. Consult the service shop where you bought the air conditioner.

If one of the following symptoms takes place, call the service shop immediately.

- The power cord is abnormally hot or damaged.
- An abnormal sound is heard during operation.
- The safety breaker, a fuse, or the earth leakage breaker cuts off the operation frequently.
- A switch or a button often fails to work properly.
- There is a burning smell.
- Water leaks from the indoor unit.



Turn the breaker OFF and call the service shop.

#### ■ After a power failure

The air conditioner automatically resumes operation in about 3 minutes. You should just wait for a while.

#### ■ Lightning

If lightning may strike the neighbouring area, stop operation and turn the breaker OFF for system protection.

## Disposal requirements



Your product and the batteries supplied with the controller are marked with this symbol. This symbol means that electrical and electronic products and batteries shall not be mixed with unsorted household waste. For batteries, a chemical symbol can be printed beneath the symbol. This chemical symbol means that the battery contains a heavy metal above a certain concentration. Possible chemical symbols are:

- Pb: lead (>0.004%)

Do not try to dismantle the system yourself: the dismantling of the product, treatment of the refrigerant, of oil and of other parts must be done by a qualified installer in accordance with relevant local and national legislation. Units and waste batteries must be treated at a specialized treatment facility for re-use, recycling and recovery. By ensuring correct disposal, you will help to prevent potential negative consequences for the environment and human health. Please contact the installer or local authority for more information.

## We recommend periodical maintenance.

In certain operating conditions, the inside of the air conditioner may get foul after several seasons of use, resulting in poor performance. It is recommended to have periodical maintenance by a specialist aside from regular cleaning by the user. For specialist maintenance, contact the service shop where you bought the air conditioner.

The maintenance cost must be borne by the user.

## Important information regarding the refrigerant used.

This product contains fluorinated greenhouse gases covered by the Kyoto Protocol.

Refrigerant type: **R410A**

GWP<sup>(1)</sup> value: **1975**

<sup>(1)</sup> GWP = global warming potential

Periodical inspections for refrigerant leaks may be required depending on European or local legislation. Please contact your local dealer for more information.

## Fault diagnosis.

### FAULT DIAGNOSIS BY REMOTE CONTROLLER

In the ARC433 series, the temperature display sections on the main unit indicate corresponding codes.

1. When the **TIMER CANCEL** button is held down for 5 seconds, a “00” indication flashes on the temperature display section.

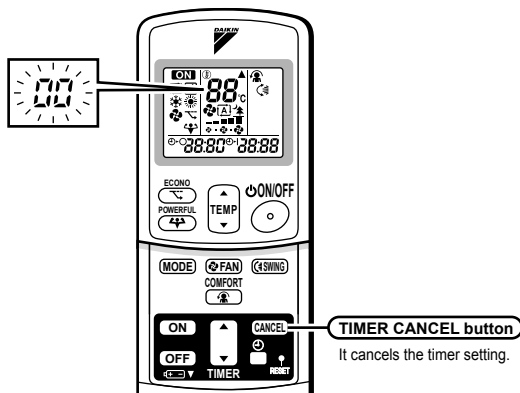

2. Press the **TIMER CANCEL** button repeatedly until a continuous beep is produced.

- The code indication changes as shown below, and notifies with a long beep.

	CODE	MEANING
SYSTEM	00	NORMAL
	UA	INDOOR-OUTDOOR UNIT COMBINATION FAULT
	U0	REFRIGERANT SHORTAGE
	U2	DROP VOLTAGE OR MAIN CIRCUIT OVERVOLTAGE
	U4	FAILURE OF TRANSMISSION (BETWEEN INDOOR UNIT AND OUTDOOR UNIT)
INDOOR UNIT	A1	INDOOR PCB DEFECTIVENESS
	A5	HIGH PRESSURE CONTROL OR FREEZE-UP PROTECTOR
	A6	FAN MOTOR FAULT
	C4	FAULTY HEAT EXCHANGER TEMPERATURE SENSOR
	C9	FAULTY SUCTION AIR TEMPERATURE SENSOR
OUTDOOR UNIT	EA	COOLING-HEATING SWITCHING ERROR
	E1	CIRCUIT BOARD FAULT
	E5	OL STARTED
	E6	FAULTY COMPRESSOR START UP
	E7	DC FAN MOTOR FAULT
	F3	HIGH TEMPERATURE DISCHARGE PIPE CONTROL
	F6	HIGH PRESSURE CONTROL (IN COOLING)
	H0	SENSOR FAULT
	H6	OPERATION HALT DUE TO FAULTY POSITION DETECTION SENSOR
	H8	CT ABNORMALITY
	H9	FAULTY SUCTION AIR TEMPERATURE SENSOR
	J3	FAULTY DISCHARGE PIPE TEMPERATURE SENSOR
	J6	FAULTY HEAT EXCHANGER TEMPERATURE SENSOR
	L3	ELECTRICAL PARTS HEAT FAULT
	L4	HIGH TEMPERATURE AT INVERTER CIRCUIT HEATSINK
L5	OUTPUT OVERCURRENT	
P4	FAULTY INVERTER CIRCUIT HEATSINK TEMPERATURE SENSOR	

## NOTE

1. A short beep and two consecutive beeps indicate non-corresponding codes.
2. To cancel the code display, hold the **TIMER CANCEL** button down for 5 seconds. The code display also cancels itself if the button is not pressed for 1 minute.

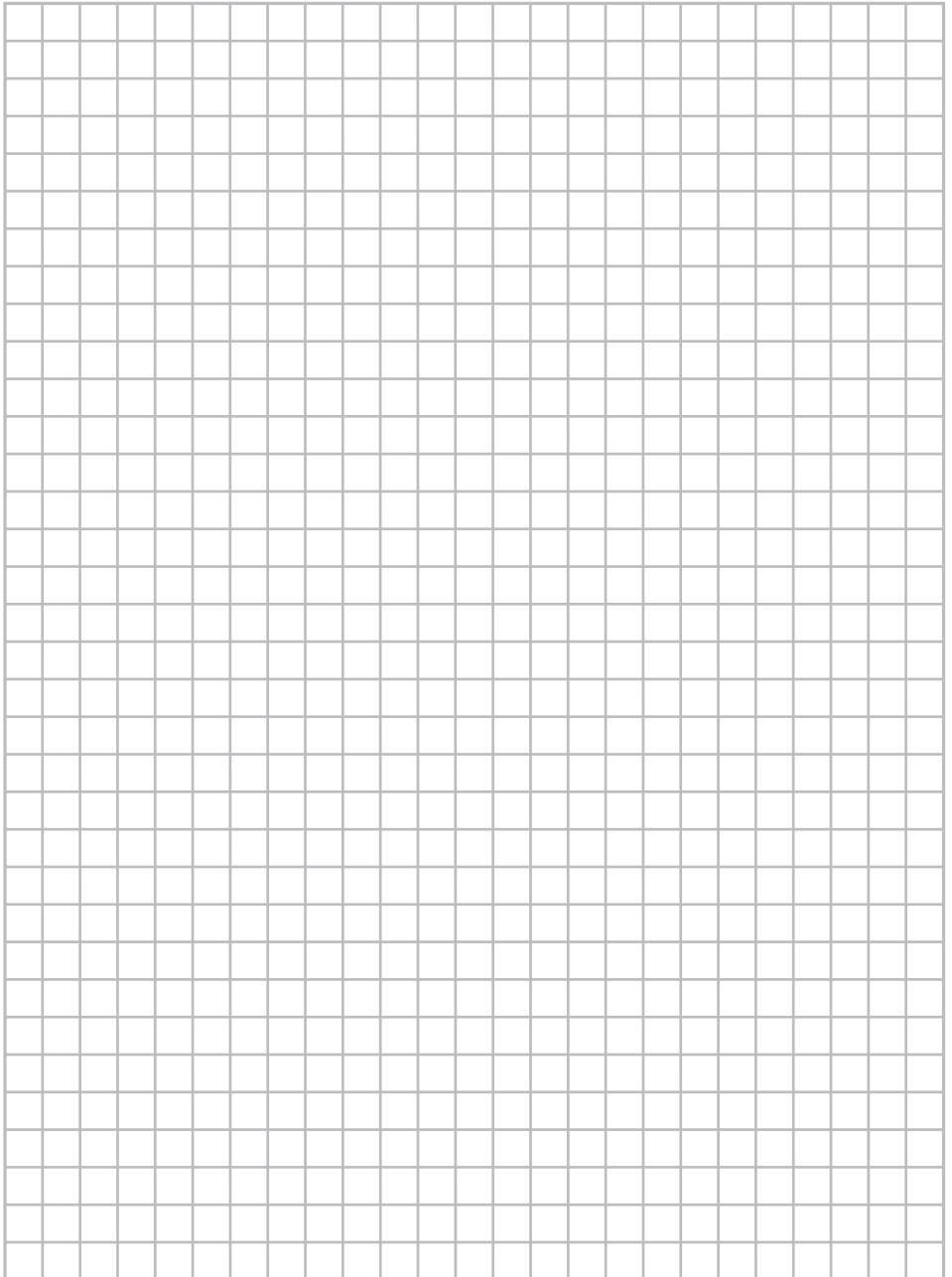

**DAIKIN INDUSTRIES CZECH REPUBLIC s.r.o.**

U Nové Hospody 1/1155, 301 00 Plzeň Skvrňany, Czech Republic

**DAIKIN EUROPE N.V.**

Zandvoordestraat 300, B-8400 Ostende, Belgium

Copyright 2014 Daikin

3P377621-2 2014.05